



greenlux
cost reduction LED lighting

Forte Series LED Linear High Bay Light

90W VEET Approved

- 30°*70°, 70°*120° & 120°*120° beam angle
- Motion & photocell sensor options available
- Dali & 0-10V Dimmable options available
- Ceiling mounted or suspended installation
- CREE chipset or SEOUL chipset available
- High quality Aluminum Alloy housing
- IP65 Rated
- No UV or IR rays. No mercury
- 5 Years Warranty
- Applications Warehouses, Convention Centres, Sporting Arenas, Large Retail Stores, Cold Storage facilities, Car Parks & Loading Docks



Mean Well Power Supply

Specifications

Colour Range	3000-6500k
Power Consumption	90W ~ 300W
Chipset	CREE or SEOUL
Lumen Output	130lm/W
Lumen Maintenance	L70 > 100,000hrs (TM-21)
Input Voltage	100V/277V AC
Operating Temp.	-30°C to 40°C
Beam angle	30° * 70° 70° * 120° 120° * 120°
CRI	>90
Power Factor	0.9
Driver	Mean Well Driver (option)
IP Rating	IP65

Dimensions & Materials

	(L*W*H)		
Dimensions (mm)	90W	348*204*145	3.8kg
	120W	460*204*145	5.1kg
	150W	574*204*145	5.9kg
	200W	687*204*145	7.0kg
	240W	800*204*145	7.9kg
	300W	913*204*145	9.3kg

Housing Material	Aluminum Alloy
Mounting options	Surface Mount/Hanging
Housing Colour	Black or Silver

Certification and Safety

Certifications	IP65, CE, RoHS, SAA, RCM
Environment	Indoor & Outdoor Location
Warranty	5 years





greenlux
cost reduction LED lighting

Forte Series LED Linear High Bay Light

Dimensions

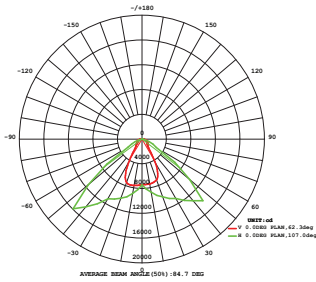

GSFOR-200W

90W

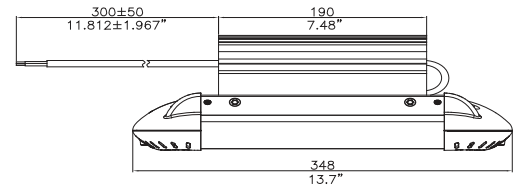
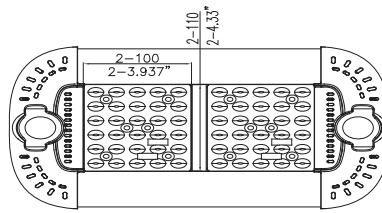

120W

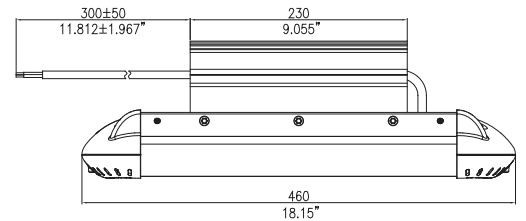
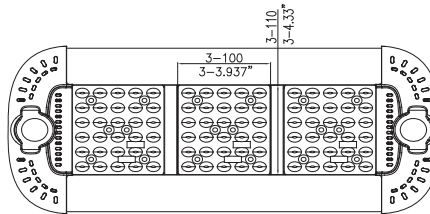

150W

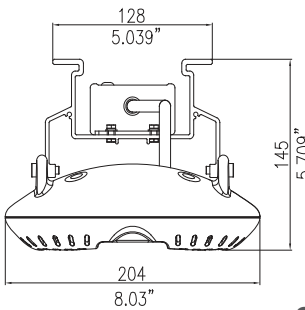
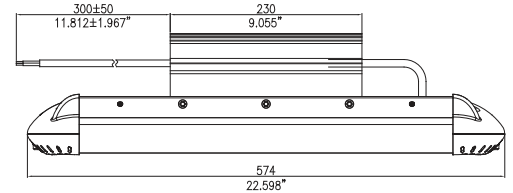
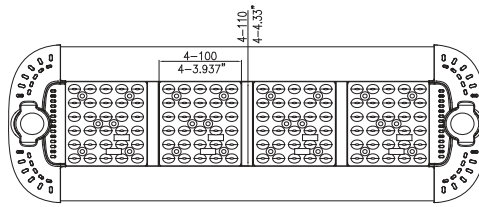

200W

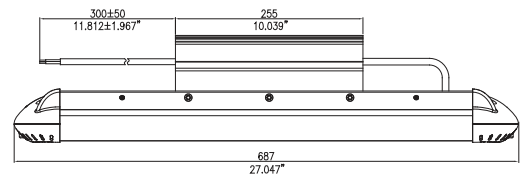
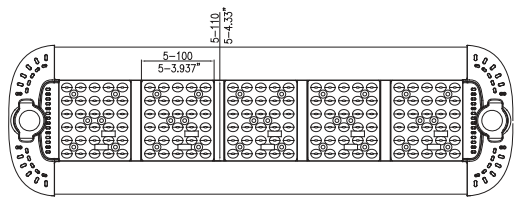

240W

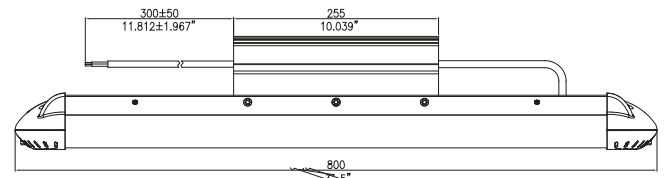
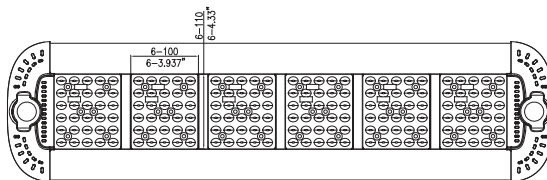

300W

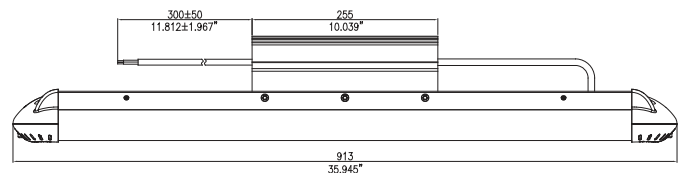
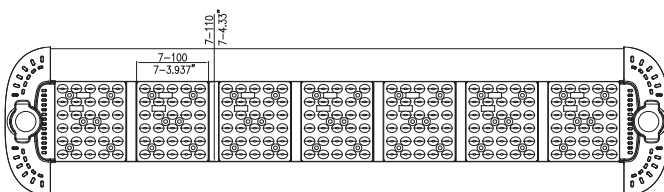



greenlux
cost reduction LED lighting

Forte Series LED Linear High Bay Light

Beam Angle

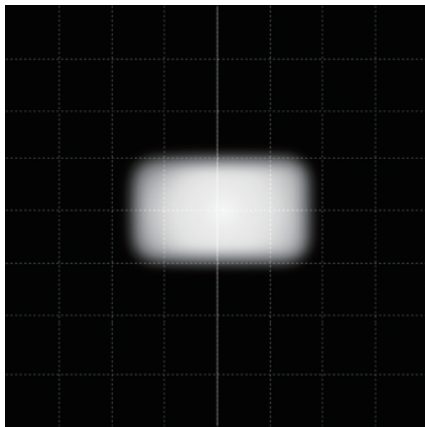

30° * 70°

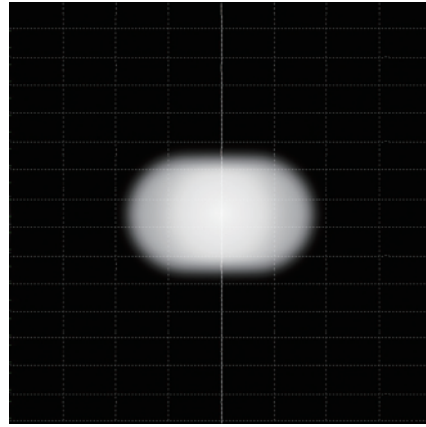

70° * 120°

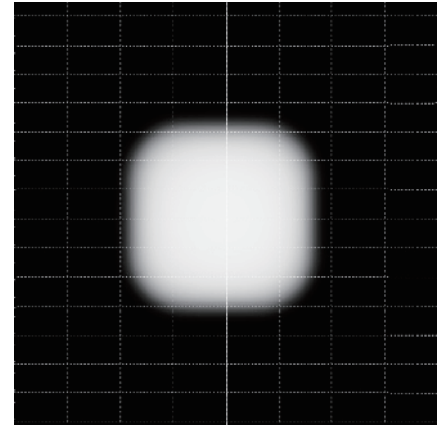

120° * 120°

Connection Diagram

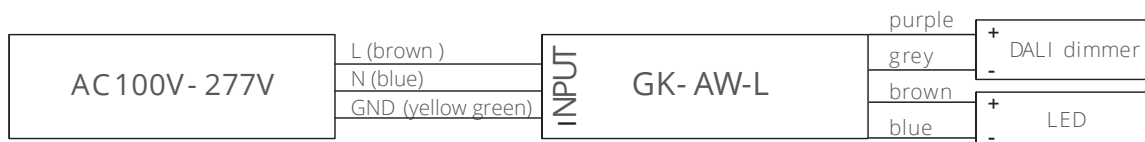

DALI dimming connection diagram

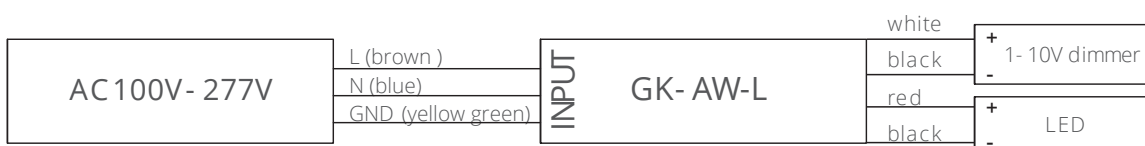

1-10V dimming connection diagram



greenlux
cost reduction LED lighting

Forte Series LED Linear High Bay Light

Available in 90W ~ 300W
80% lumen maintenance at 50,000 hours

Product Range

Model#	Dimension (mm)	CCT	Lumens	Wattage	LED
GSFOR-90W	348*204*145	3000-6500k	11700	90W	CREE or SEOUL
GSFOR-120W	460*204*145	3000-6500k	15600	120W	CREE or SEOUL
GSFOR-150W	574*204*145	3000-6500k	19500	150W	CREE or SEOUL
GSFOR-200W	687*204*145	3000-6500k	26000	200W	CREE or SEOUL
GSFOR-240W	800*204*145	3000-6500k	31200	240W	CREE or SEOUL
GSFOR-300W	913*204*145	3000-6500k	39000	300W	CREE or SEOUL

